



# OWNER'S MANUAL

**RSL-2701U** (for CANADA MODEL)

**RSL-2701S** (for USA MODEL )



Read all instructions carefully before use.

For any Customer Support needs please choose the  
Customer Support tab on [www.royalsovereign.com](http://www.royalsovereign.com)

**Royal Sovereign International Inc.**

[www.royalsovereign.com](http://www.royalsovereign.com)

## TABLE OF CONTENTS

<b>TOPIC</b>	<b>PAGE</b>
1. Introduction .....	3
2. Package Contents.....	3
3. Safety Precautions.....	4
4. Parts .....	5
5. Control Panel .....	6
6. Features Guide.....	8
7. Film Loading and Threading .....	9
8. Operation Instructions.....	13
9. Maintenance .....	13
10. Trouble Shooting Guide.....	14
11. Specification .....	15
12. Warranty .....	16

# TABLE TOP LAMINATOR

## 1. INTRODUCTION

Thank you for purchasing the Table Top Laminator. It has been designed and manufactured to provide years of continuous service. For high quality lamination, please read this instruction manual thoroughly. This manual will provide you with complete operating and maintenance information.

## 2. PACKAGE CONTENTS

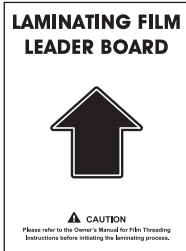
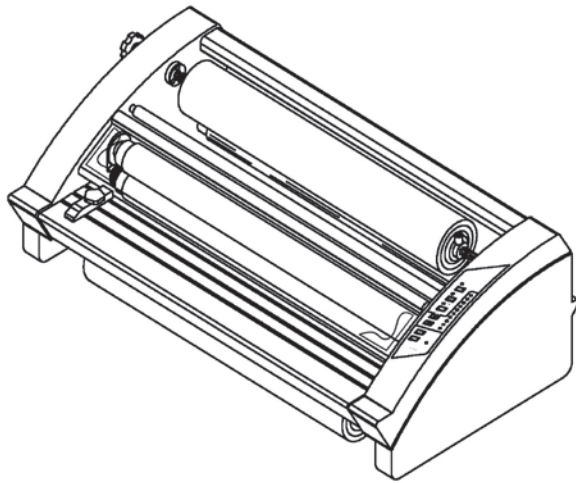

Film leader board



Manual

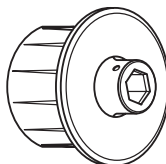

Core 4EA



Fuse

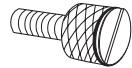

Core bolt 4EA

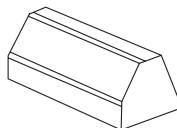

Dust cover

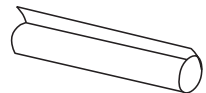

Sample roll film 2EA

### 3. SAFETY PRECAUTIONS

**Failure to comply with any of the following safety procedures could result in serious injury. Please read the instructions carefully and keep for future reference.**

1. Only a licensed electrician should install wiring and outlet for the laminator.
2. Ensure the unit is plugged into a properly grounded outlet with the correct voltage.
3. Keep hands and clothing (i.e. Neckties) away from rollers. The rollers have pinch points that can trap body parts or clothing and cause serious injury.
4. Keep flammable and wet objects away from the machine.
5. Place machine on a level surface.
6. Avoid excessive sunlight, humidity and extreme temperatures.
7. Ensure the unit is turned off, cooled, and unplugged from the outlet prior to moving and/or repairing.
8. Keep out of reach of children.
9. Only authorized maintenance and service technicians should make repairs.
10. Do not attempt to laminate items that exceed total recommended material thickness for the unit
11. When cleaning the machine, don't use flammable sprays or materials.
12. Do not touch the rollers when hot.  
Do not place any foreign objects inside the laminator.
13. Do not cover the surface of the machine until the machine has completely cooled.
14. You can laminate by single film when the switch in the left cover is "O".  
(Insure the machine drastically cold, press the button in the left cover be " O ", then you can laminate by single side. It is a damage for the paper to laminate by single side while the rollers up and low are heating all together.)  
- Model applies RSL-2701S only for USA.

# TABLE TOP LAMINATOR

## 4. PARTS

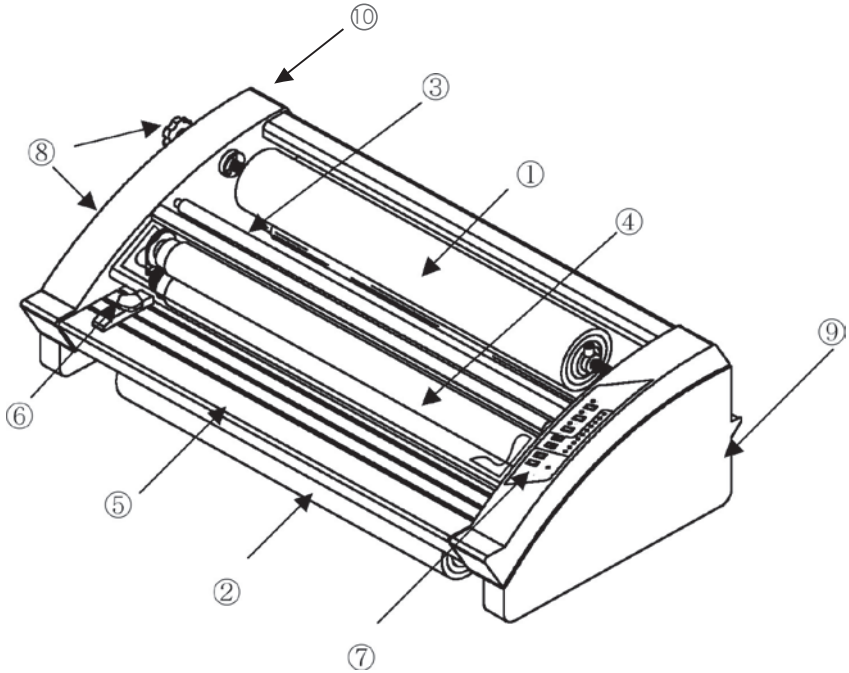

- |                  |                 |                 |
|------------------|-----------------|-----------------|
| 1. Upper Film    | 2. Lower Film   | 3. Idle Bar     |
| 4. Hot Rollers   | 5. Feed Table   | 6. Paper Guide  |
| 7. Control Panel | 8. Tension Knob | 9. Power Switch |

\*10. (2701S model only) Single/Double Laminating Switch "0" (on) "1" (off).

\* For Single-side Laminating.

## 5. CONTROL PANEL

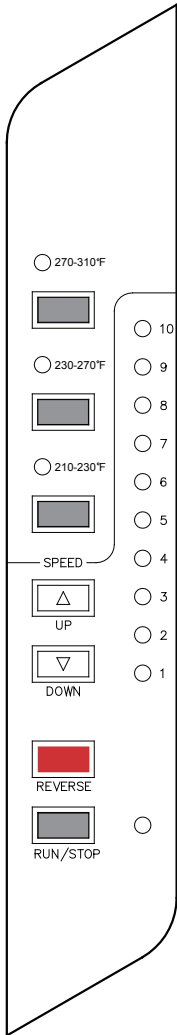

270 ~310 °F

Film Application Temperature  
270 ~310 °F

230 ~270 °F

Film Application Temperature  
230 ~270 °F

210 ~230 °F

Film Application Temperature  
210~230 °F



Increase roller speed  
(1~10 speed settings)



Reduce roller speed  
(1~10 speed settings)



Reverse the rollers to undo jams and correct  
misfed documents



Run and stop the machine

RSL-2701U

# TABLE TOP LAMINATOR

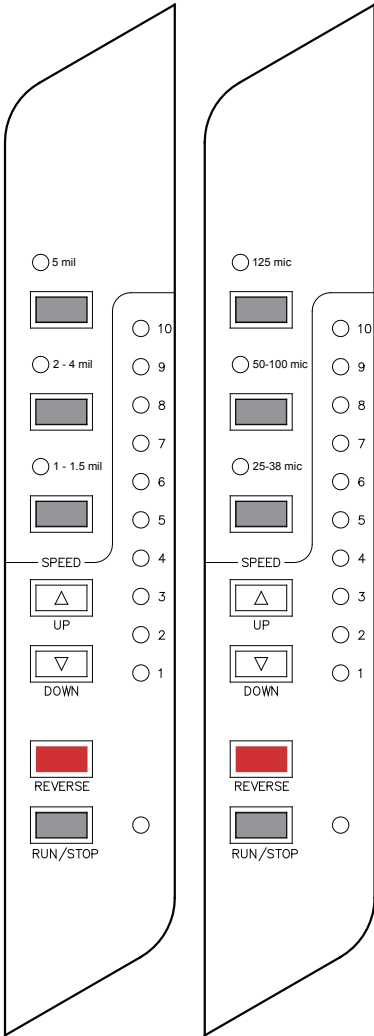

RSL-2701S

125mic * (100~125mic)	Film Application Thickness 125mic(100~125mic)
--------------------------	--

50~100mic * (50~75mic)	Film Application Thickness 50~100mic(50~75mic)
---------------------------	---

25~38mic * (25~38mic)	Film Application Thickness 25~38mic(25~38mic)
--------------------------	--



Reduce roller speed (1~10 speed settings)
--



Increase roller speed (1~10 speed settings)
--



Reverse the rollers to undo jams and correct misfed documents
---



Run and stop the machine
--------------------------

\* For Single side Laminating.

## 6. FEATURES GUIDE

### Power Switch ①

Located on the rear of the machine. "I" (on) "O" (off). (Fig. 2)

### Cross Cutter ②

Used to cut off the laminated web. (Fig. 2)

### Feed Guide ③

The feed guide permits alignment of the item(s) to be laminated. To position the adjustable guide, loosen the knob, slide it to the desired position and tighten the knob to secure the feed guide in place. (Fig. 3)

### Safety Cover ④

Cover + Protect the hot rollers.

NOTE: If the safety cover is opened, this rollers stop turning.

### Film Shaft and Locking Core Adapter ⑤

The film shaft holds the film supply on the machine. The locking core holds and locks the film on the shaft to prevent shifting. (Fig. 4)

### Film Tension Adjustment ⑥

Allows the operator to increase or decrease roll film tension. To increase the tension turn the knob clockwise and to decrease tension turn the knob counterclockwise. (Fig. 5)

**NOTE:** - Excess tension on the top roll feed will cause upward curl.  
 - Excess tension on the bottom roll feed will cause downward curl.  
 - Tension should be adjusted until the laminated materials exit flat.

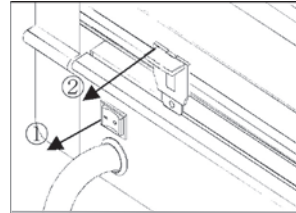

Figure 2

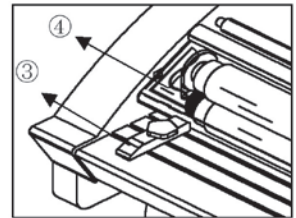

Figure 3

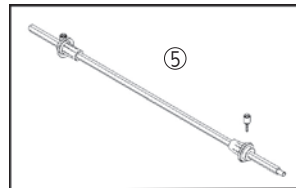

Figure 4

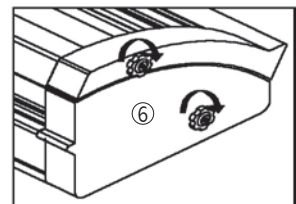

Figure 5



## 7. FILM LOADING & THREADING

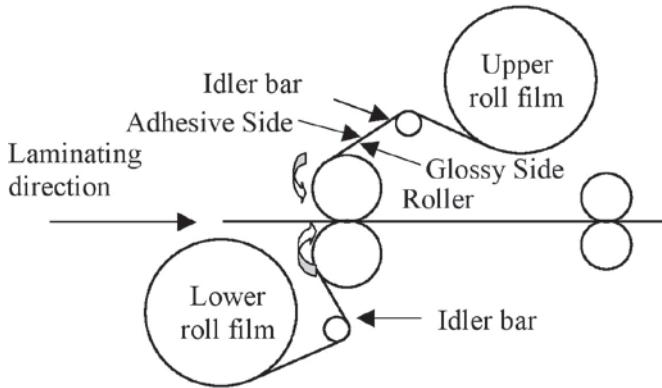

Figure 6

1. Slightly slide the upper film shaft to the right and pull it out from the machine. (Fig. 7)

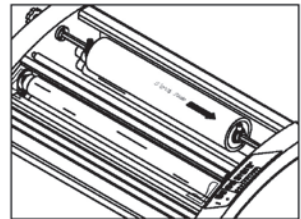

Figure 7

2. Take both lock core adapters off from the shaft. (Fig. 8)

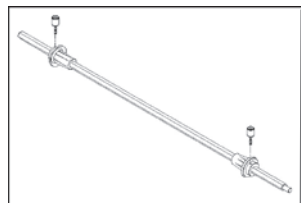

Figure 8

3. Insert one of the core adapters into the right end of the film core. For film with poly-in (adhesive side is inside the web), make sure the adhesive side is facing upward. (Fig. 9)

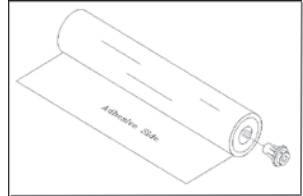

Figure 9

4. Insert the film shaft into the roll of film from the right side with the copper end last. Align and insert the core adapter on the left end of the film core. (Fig. 10)

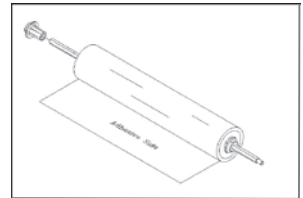

Figure 10

5. Center the film on the shaft and lock it in place with the locking core adapters. (Fig. 11)

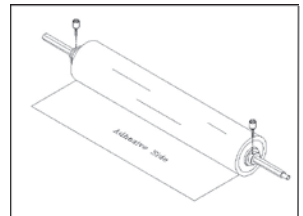

Figure 11

6. Carefully return the film shaft back into place. (Fig. 12)

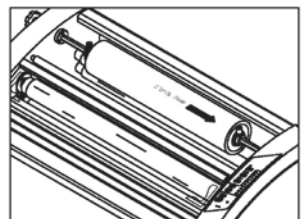

Figure 12

## LOADING LOWER ROLL FILM

1. Repeat steps 1-5 to load the lower roll film.
2. Once the upper and lower film is on the shaft, pull the film from the top and roll down to the bottom roll to make certain that the film is aligned properly. Then tighten the lower locking core screws.

**NOTE:** If the film is not aligned properly exposed adhesive will adhere to the rollers and may cause the film to jam.

## FILM THREADING / WEBBING

1. Set the temperature and speed according to the Recommended Temperature and Speed section.
2. Remove the Front Table.
3. Pull down the upper film over the Safety Cover to the lower film; align and center the lower film to upper film. (Picture 1)
4. Rewind the upper film until the film aligns with the Safety Cover.
5. Thread the film over the Upper Idle Bar and underneath the Safety Cover and pull down until it drapes over both upper and lower hot rollers. (picture 2)
6. Carefully pull up the laminate from the lower roll up and drape it over top of the upper film (over the top hot roller). (picture 3)
7. Reinstall the Front Table and close the Safety Cover.
8. Insert and push the leader board into the hot rollers and press the Run button. (picture 4)
9. Press the Stop button when the leader board has completely exited the rear of the laminator.
10. Use the Cross-Cutter to remove the leader board.
11. Trim any excess film off of the leader board. The leader board can be re-used.

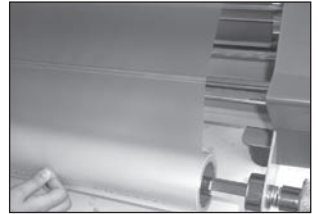

Picture 1

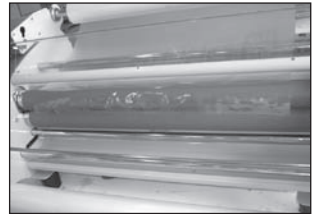

Picture 2

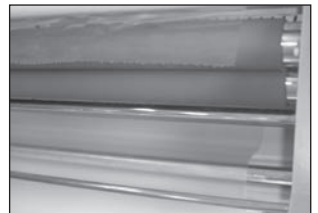

Picture 3



Picture 4

**LAMINATING SINGLE SIDED** (RSL-2701S USA Model only)

Press the switch into the location "SINGLE".

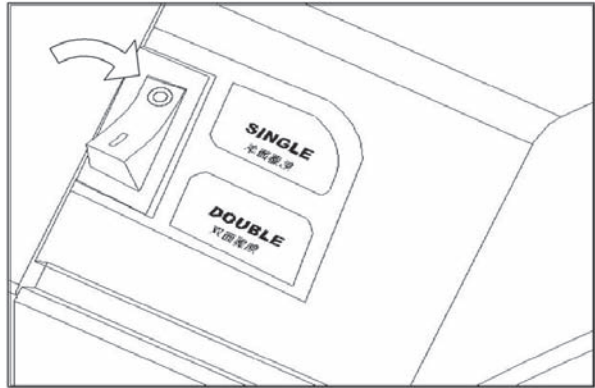

Figure 13

## 8. OPERATION INSTRUCTIONS

1. Turn the laminator ON (I) located on the rear of the machine. (Fig. 2)
2. Choose appropriate laminating temperature and speed. (Fig. 1)
3. Do not begin laminating until the blinking light is steady (approximately 8 minutes).
4. Position the item to be laminated on the feed table.
5. Press the RUN button. The rollers will begin to turn, and feed the item into the machine.
6. Insure the machine drastically cold, press the button in the left cover be " O ",then you can laminate by upper roller for single laminating.(It is a damage for the paper to laminate by single side while the rollers up and low are heating all together.)  
- Model applies RSL-2701S only for USA.
7. The first paper is bad while OPP film laminating, please use a test paper first and then the second paper must keep the distance less than 15mm form the front one.  
- Model applies RSL-2701S only for USA.
8. Stop the laminator when all of the items have completely exited the rear of the machine.
9. Adjust top + botton roll feed tension until lamination is flat.  
(See film tension adjustment page 8.)

**NOTE:** Stand by mode and auto power off mode

- Stand by mode: If no activity is made within 30 minutes after each use the machine will automatically switch into stand by mode. (In stand-by mode the temperature will decrease to 80~90°C and the three temperature setting indicators will blink).
- Auto power off mode: If the machine is in stand by mode and no activity is made for 60 minutes the machine will automatically power off.
- If any activity is made while in stand by or auto power off mode the machine will return to it's previous stage.

## 9. MAINTENANCE

1. Do not apply any cleaning fluids to the rollers certain fluids may cause damage.
2. Do not clean rollers with sharp or pointed objects.
3. Use a crepe rubber cleaning block to remove adhesive from rollers. Works best when rollers are hot.
4. Use a damp cloth with water to clean the body of the machine.
5. Store machine in a dry clean area.

## 10. TROUBLE SHOOTING GUIDE

Symptom	Cause	Possible Solution
Rollers do not operate after the RUN/ STOP button is pressed	<ol style="list-style-type: none"> <li>1. Safety cover is opened</li> <li>2. Power cord is not plugged in</li> <li>3. Front table is not on properly</li> <li>4. Machine is not turned on</li> </ol>	<ol style="list-style-type: none"> <li>1. Check safety cover is properly closed</li> <li>2. Plug in the power cord</li> <li>3. Check installed properly</li> <li>4. Turn the machine on</li> </ol>
Roller is not heating	Call your authorized dealer	Call your authorized dealer
Poor Lamination	<ol style="list-style-type: none"> <li>1. Film tension is unbalanced.</li> <li>2. Lower idler bar is not located in proper position</li> <li>3. Wrong temperature / speed setting</li> </ol>	<ol style="list-style-type: none"> <li>1. Adjust film tension</li> <li>2. Push idler bar in proper position</li> <li>3. Follow manufacturer's recommended temperature and speed</li> </ol>

# TABLE TOP LAMINATOR

## 11. SPECIFICATIONS

MODEL		RSL-2701U	RSL-2701S	RSL-2701	RSL-2701S	RSL-380S	
Power supply		AC120V 60Hz		AC100V 60Hz AC220~240V 50/60Hz	AC 220~240V 50/60Hz		
Power consumption		1450W		1500W			
Max laminating width		685mm				380mm	
Film thickness		25~250mic /1~10mil		25~125mic/1~5mil			
Max laminating speed		2.5m/min				3m/min	
Ready time		10min					
Heating method		Hot Roller					
Driving motor		DC geared motor					
Temperature control		Digital(micom)					
Speed control		Digital(10steps)					
Transport type		4Roller					
Cross cutter		Yes					
Hot lamination	Single	No	Yes	No	Yes	Yes	
	Double	Yes					
Reverse		Yes					
Dimensions(w×d×h)		920×520×320mm				550×520×320mm	
Unit weight		50kg				30kg	

## 11. WARRANTY

Royal Sovereign International warrants the equipment sold is free from defects in material and workmanship for a period of One (1) year for Parts and Labor from the date of installation, excluding lamination rollers which are warranted for Six (6) months. This warranty is extended only to the original purchaser. This warranty is the only warranty made by Royal Sovereign International and cannot be modified or amended. Royal Sovereign's sole and exclusive liability and the customer's sole and exclusive remedy under this warranty shall be, at Royal Sovereign's option, to repair or replace any such defective part or product. These remedies are only available if Royal Sovereign's examination of the product discloses to Royal Sovereign's satisfaction that such defects actually exist and were not caused by misuse, neglect, attempt to repair, unauthorized alternation or modification, incorrect line voltage, fire, accident, flood or other hazard.

All warranty claims must be filed through the authorized Royal Sovereign dealer or reseller through which the equipment was originally purchased. Model, serial number and date of delivery are required for all claims.

The warranty made herein is in lieu of all other warranties, expressed or implied, including any warranty or merchantability or fitness for a particular purpose. Royal Sovereign will not be liable for personal damage or personal injury (unless primarily caused by its negligence), loss of profit, or other incidental or consequential damages arising out of the use or inability to use this equipment.

### LIMITED WARRANTY

This warranty specifically does not cover damage to laminating rollers caused by knives, razor blades, or any sharp objects or abrasives, or failure caused by adhesives, or damage caused by lifting, tilting or improper use of the machine. Warranty repair or replacement by Royal Sovereign or its authorized Reseller(s) does not extend the warranty beyond the initial one year period from the date of installation. Unauthorized customer alterations will void this warranty.

#### **ROYAL SOVEREIGN INTERNATIONAL INC.**

2 Volvo Drive Rockleigh, NJ 07647 USA  
TEL : +1) 800-397-1025  
FAX : +1) 201-750-1022  
E-mail : [info@royalsovereign.com](mailto:info@royalsovereign.com)

#### **RS CANADA INC.**

1025 Westport Crescent, Mississauga ON L5T 1E8  
TEL : +1) 905-461-1095 FAX : +1) 905-461-1096  
TF: +1) 866 961-6673  
E-mail : [info-ca@royalsovereign.com](mailto:info-ca@royalsovereign.com)

#### **RS HOLLAND B.V.**

Industrieweg 6K, 4104AR, Culemborg, The Netherlands  
Tel: +31 (0)345 473 097  
Fax: 31 (0)345 519 811  
[eu.sales@royalsovereign.com](mailto:eu.sales@royalsovereign.com)

#### **RS INTERNATIONAL AUSTRALIA PTY. LTD.**

30 Prime Drive, Seven Hills, NSW 2147, Australia  
TEL : +61) 2-9674-2127  
FAX : +61) 2-9674-2027  
E-mail : [salesaust@royalsovereign.com](mailto:salesaust@royalsovereign.com)